

D5.2

DTN Node User Documentation

DTN Node Build

Version 2.0

n4c-wp5-052-dtn-node-build-12.doc



ABSTRACT

Starting in May 2008, N4C is a 36 month research project in the Seventh Framework Programme (FP7, www.cordis.lu/fp7). In cooperation between users in northern Sweden and the Kočevje region in Slovenian mountain and partners, the project will design and experiment with an architecture, infrastructure and applications in field trials and build two test beds.

This document explains how to build a DTN2 Village Router.

Acknowledgements

Due date of deliverable: 31/October/2010 Actual submission date: --/---/----

		Document history	
Version	Status	Date	Author
0.1	Created	22/01/2010	Eoin Meehan Kerry Hartnett
1.0	Created	02/03/2010	Eoin Meehan Kerry Hartnett
2.1	Draft	20/02/2011	Kerry Hartnett
2.2	Final	22/03/2011	Kerry Hartnett

Dissemination level		Level
PU = Public		x
PP = Restricted to other programme participants (including the Commission Services).		
RE = Restricted to a group specified by the consortium (including the Commission Services).		
CO = Confidential, only for members of the consortium (including the Commission Services).		

CONTENTS

1.	INTRODUCTION.....	4
2.	AUDIENCE	4
3.	BUILDING A DTN2 VILLAGE ROUTER.....	5
4.	BUILD REFERENCE DOCUMENTS.....	29
5.	CHECKLIST FOR VILLAGE ROUTER BUILD:	36

1. INTRODUCTION

This document explains how to build a DTN Village Router used in the Summer Tests 2009 and updated for the summer tests in 2010 in Northern Sweden. Some changes were made to the original design as a result of the experiences of working with this technology in the field and these have been incorporated in this document. This document has evolved over the term of the project.

2. AUDIENCE

This document is intended for two audiences: the first is those who wish to build a Village Router for their own use or as part of the N4C project. The second is those who may be required to support the Village Routers when deployed in the summer 2010 trials.

Some of these routers will be deployed for extended periods in remote locations and so the TCD/Intel staff will most likely not be available to execute repairs or investigations should problems occur with the routers.

It is desirable that other N4C project staff should be able to perform basic troubleshooting and reconfiguration should they be close to a Village Router and this document will explain to them the components and assembly.

3. BUILDING A DTN2 VILLAGE ROUTER

Process Owner:	TCD/Intel	Date for Review:	20-03-2011
Product Name:	DTN2 Village Router	Expiration Date:	
Document Owner:	Kerry Hartnett	Audited by:	Shane Brodie Aidan Lynch
Rev:	2.1	Approved by:	
Date of Issue:	15 th Mar 2010 21 st Mar 2011 updated	Status:	Final
Journal		Estimated time to complete procedure:	5 hours

Purpose (Who Should Do This When and Why):	This script should be followed by those who are going to build a Village router for the N4C project.
What You Will Need:	<p>Have all the tools required near at hand.</p> <p>You will need a list of products mention in the Bill Of Materials in associated document.</p> <ul style="list-style-type: none"> A set of screw drivers (including at least a M3 Pozidrive) Tie wraps size 5, luggage straps from IKEA Wire cutter A variable speed drill with size 4 bit for the matrix board and metal board Hack Saw, maybe Super Glue, Craft knife <p>You will also need to have access to:</p> <ul style="list-style-type: none"> Mounted Power Drill with a ¾ inch chuck. Bit sizes 10mm, 15 mm, 6mm and 3mm or 3.5mm Bench power supply for testing boards (12v, 2A) or a home made power supply from old laptop that output between 10 and 20 v and 4 Amps
What You Should Know:	You should have a basic understanding of battery power, and a good understanding of Linux (Ubuntu) and the DTN software to complete the final configurations.
Caution:	Ensure the Positive and negative wires DO NOT TOUCH when wiring the batteries. There is a danger of personal injury should this happen!
Related Documentation	N4C village router design
Document structure	<p>The first part will explain how to put the box together as a working system</p> <p>The second section on how the operating system and village build is applied to the board, this can be done before or after the box build is completed.</p> <p>The third part explains the solar stand and solar panel setup.</p>

Step 1- Drilling

SECTION 1: PUTTING THE ROUTER TOGETHER

We will be putting holes in 3 boards, the Mounting Plate, Enclosure Gland Plate and PCB mounting matrix board.

1. **Mounting plate** - Open the enclosure and remove the mounting plate. Get the plate holes drilled based on drawing PL1. (4 x PCB mounting points) This could require a bench drill as the plate is too hard for a hand drill or a good steady hand drill
2. **Gland plate** - Next drill holes in the removable gland plate at the bottom of the box, drill holes based on drawing PL1 (holes for switch, antenna and power). Again use a bench drill.
3. **Support board** - Take the Matrix boards and join 2 together to make a board size 128mm x 192 mm. Cut a 1.5cm or 2cm piece of matrix board and use this strip to glue the two boards together with super glue. Drill holes into the matrix support board as per drawing PL2. This can be done with a hand drill
Screw 8mm spacers into matrix board.

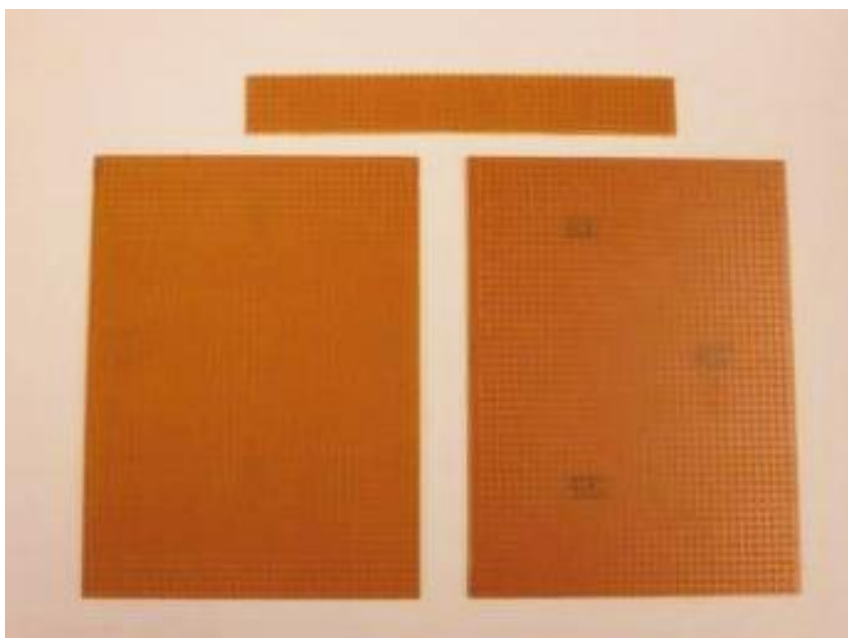

FIGURE 1 PCB SUPPORT BOARD ELEMENTS

Step 2- Earth Bolt Removal

The Sarel enclosure has two earth bolts on the inside surface of the box. We do not require these and they reduce the amount of space for the batteries.

Take the hack saw and remove the earth bolt at the hinge side of the box. (You can leave the other bolt if necessary).

It is not necessary to complete this for the build to be successful but it gives extra space. We did not complete this for the summer 2011 trials.

This is a difficult job so you may need to use a power tool such as a small angle grinder or powered hacksaw.



FIGURE 2 EARTH BOLT REMOVED

Step 3- Cable assembly

We need to create 2 cable assemblies; a power supply/phidget connection and a battery connection. In the summer 2011 build we removed the need for the MikroTik board by using a WiFi Atheros card. This reduced power and increased the space we had to use.

1. **Power cable assembly.** See *drawing CA1*. We improved this from summer 2009 design, we now only have one board to power but it goes through a set of sensors.
 - a. We added Phidgets sensors (Small sensors bought from phidgets.com) in the summer 2010 build to monitor the voltage of the batteries and the AMPs we were generating and using. The cable assembly for this is shown below.

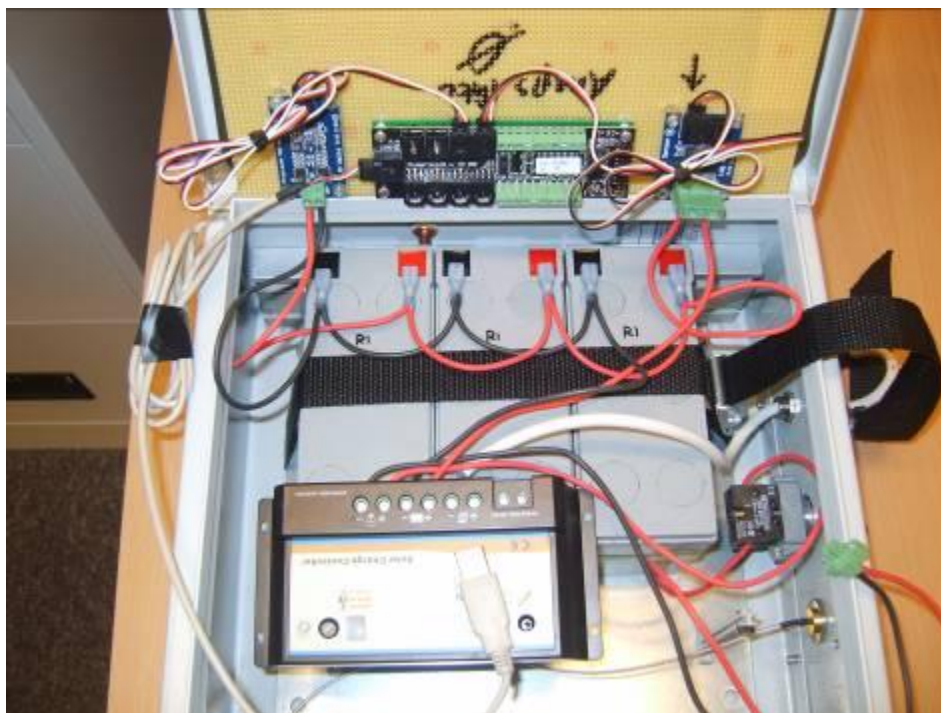

FIGURE 3 BATTERY AND PHIDGET HARNESS

2. **Battery connection,** See *drawing CA2*. This cable assembly links the 3 batteries in parallel, giving us 21 Amp Hours at 12v.
Cut wire into 8 x 25 cm sections 4 of red (Positive) and 4 of black (negative) one set.

Strip an end and put on crimp terminals. Crimp the cables to the connector. There should be a tail hanging off each end of the assembly. Link the cables in parallel as per picture below. We will connect to the batteries in step 9. Leave about 25cm of cable free to help with cable management from battery pack to controller.

Note: we have used red and black wire – you can use different colours but the standard should be red and black or blue and brown. Red for live/positive and black for earth/negative



FIGURE 4 BATTERY HARNESS

Step 4- Enclosure gland plate assembly

Power Switch

Take the enclosure gland with holes and assemble the power switch into the centre hole. The switch comes in 2 parts, the switch body and wire connection body.

Insert the switch through the hole from the outside of the plate, then slide the connection body onto the switch from the inside. Turn the switch body to lock it to the connection body (it's a bayonet fitting) and then screw the two locking glands down to secure the entire switch. The locking screws push against the gland plate



FIGURE 5 CONNECTION BODY



FIGURE 6 SWITCH BODY

For ease of connection the wire assembly on the Connection Body can be removed by unscrewing the single holding screw.

Antenna Connection

Next we have the Antenna connection which goes into end hole. The pig tail cable on this will attach to the Atheros card. Remove the locking nut, slide the connector through the hole then screw down the locking nut from the inside.

Power Cable

Remove the locking nut from the cable gland, loosen the cable grip and slide the gland into the hole. Screw down the locking nut from the inside.

The power cable which is a circular 3 core cable (*ref power cable*) coming in from the external junction box. Fit this cable through the power cable gland (see below) and leave about 25cm free inside the box for cable management. You don't have to tighten the cable grip yet if you want to leave room for adjustment, but don't forget to do this before taking the unit outdoors.

We will connect this cable to the IP66 junction box at a later point.



FIGURE 7 POWER CABLE GLAND



FIGURE 8 FINISHED GLAND PLATE

Step 5- Add fixings to plate

Pull through the battery holding strap, keep its length at 100 cm each and ensure you have enough to wrap the three batteries together. You will need to keep the buckle on one side of the battery pack.

Position the PCB card holders (item 5) over their holes and screw them to the plate. That you drilled out at the start.



FIGURE 9 POSITION OF PCB HOLDERS

Step 6- Test board power

Before commencing with assemble, test boards power up.

This can be done with a variable voltage power adapter and correct adaptors or a power bench with correct settings.(12v) min (2Amps) You can also make up a power supply using an old laptop power supply that outputs between 10v and 25v and 4.5 amps. If you make your own you need to cut off the existing connection and attach the power connector for the proteus carefully making sure the positive and negative are attached correctly. Use the power assembly cables to test the power. See figure 13

All we want to do here is test that the LEDs come on, before we assemble the board into the enclosure.

Step 7- Battery placement



Get two of the large tie wraps and join them together to make it longer. The close of the loop around the battery pack to keep it together. Place the batteries in the box and loop the pre installed battery support strap around the battery pack, and tighten the strap.

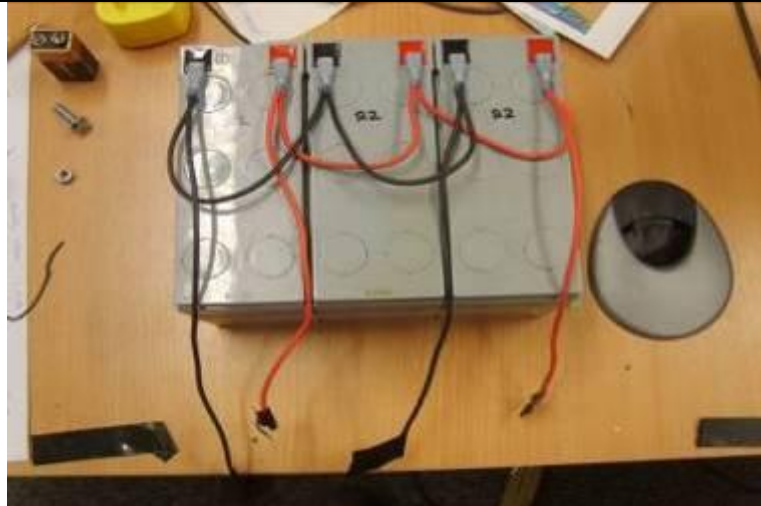

FIGURE 10 BATTERY WIRING

Put some tape on the exposed ends of the battery harness (to stop them shorting) and link the batteries together with this battery harness.

Warning: connect all the positive terminals first, and then connect all the negative terminals. If you connect the negative terminals first, there is a danger of the positive terminals “sparking” when you go to attach them. Attaching the positive first and negative second eliminates this risk.

Warning: Do not allow the positive and negative cables to touch or the battery will short. There is a danger of physical harm.

Step 8- Mount the cards on support board

Place the board on the support board as per picture and location on diagram PL1. Ensure the LVDS socket is exposed on the top side of the assembly. Insert screw into through the board mounting holes and the into the separator supports. Complete this on all support holes identified.

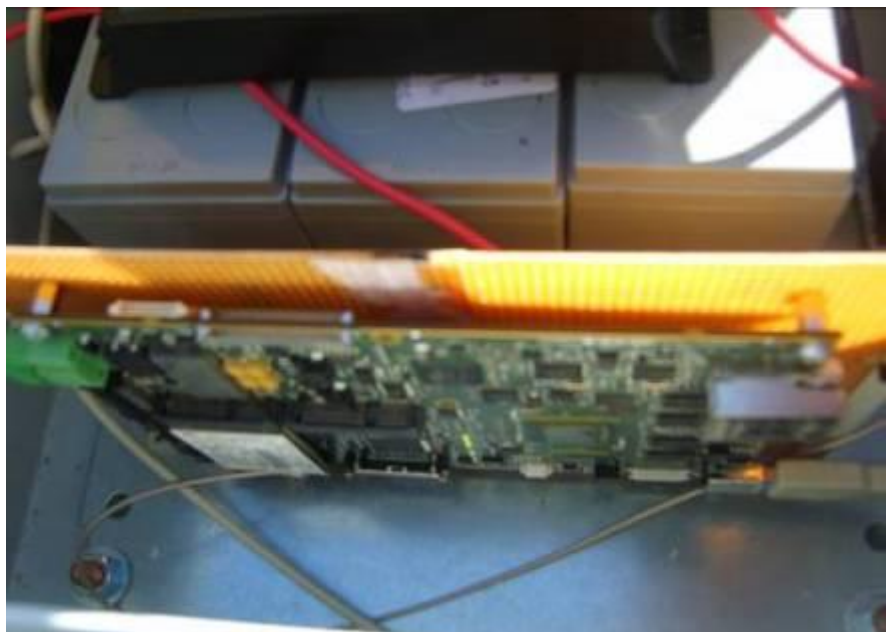

FIGURE 11 BOARD TOP VIEW



FIGURE 12 PROTEUS BOARD ON MOUNTING

Step 9- Slide boards into holders

Take the support board with the circuit board now attached, and slide it down into the vertical board holders.

The two black buttons on the support holders are locks; press them and they should lock into place with a “click”.

Step 10- Wiring the on/off switch

The power for the board will come off the load on the solar controller. .

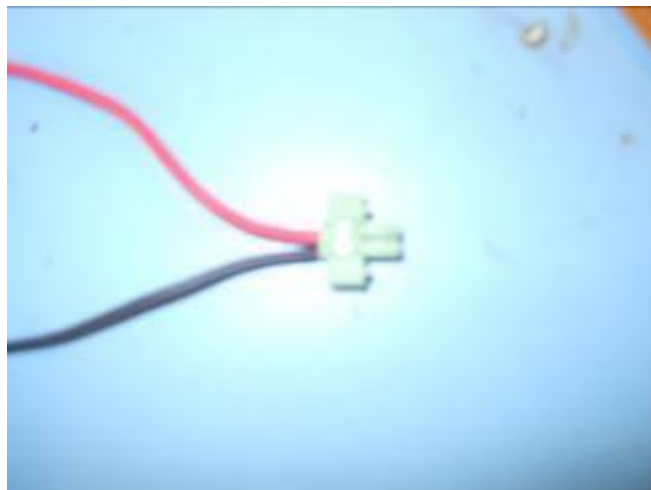

FIGURE 13 WIRING OF PROTEUS PLUG

Take the power off the load (bulb) on the charge controller (positive and negative) into the switch. At the switch attach the positive to one side of the switch and on the far side of the switch continue positive with negative into an electrical plug. (above)

Step 11- The Phidget setup

The phidgets are connected mounted on matrix board also. We have three parts to this monitoring setup

1. The 1203 - PhidgetTextLCD 20X2 : White or Blue: Integrated PhidgetInterfaceKit 8/8/8
2. 1122 - 30 Amp Current Sensor AC&DC
3. 1135 - Precision Voltage Sensor
4. The board is Plain 39117 300m x 100m none 39 x 117

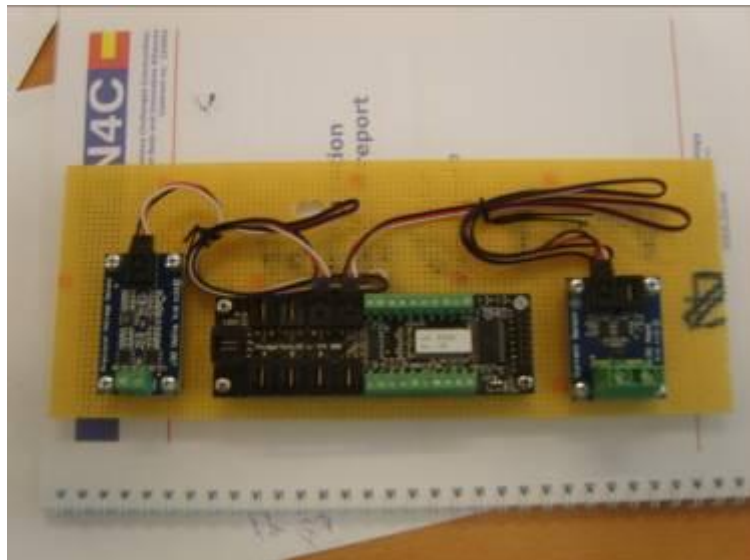

FIGURE 14 PHIDGET ASSEMBLY ON MOUNTING BOARD

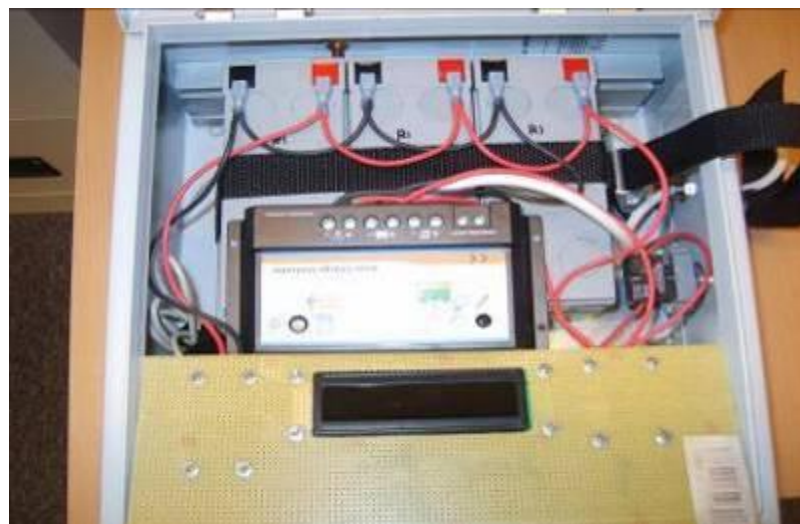

FIGURE 15 INSIDE THE BOX

5. The phidget board is connected to the proteus via a USB cable provided. Once the cable is connected to the board we read the readings from the voltage monitor and the Amp monitor to track the state of the batteries and we make decisions on staying up or shutting

down based on these. The reason we do this is to avoid multiple power on and off of the system and try keep it in a controlled state.

- a. We shut down the board into a STANDBY SHORT when the battery voltage hits 1145v. This puts the system to sleep for 30 minutes , it then wakes and senses the voltage again, if its going up past the 1145v it stays up. If it's below it goes to sleep again for 30 minutes.
- b. If the voltage drops to 1135v we put the box to sleep for 3 hours. It will wake after this time and check the voltage and make a decision based on the reading.
- c. The Amps reader lets us know the state of the battery charging and helps trouble shoot and gather data on charging.

Step 12- Connect Antenna pigtail

When the board is in place in the box we can attach the antenna pigtail to the wifi card. This can be difficult, there is a limited number of times these connections can be pushed on and off so only put this on when you are happy everything else is in place.

Step 13- Wiring the solar

The three solar panels in a typical configuration use a 4-into-1 connection. The single supply cable from this connector is a flat cable which is not ideal for ensuring a waterproof connection at the enclosure. Therefore we have to "convert" this cable to a standard circular three core cable and use this to bring the power into the enclosure.

To do this we use a standard electrical connector block. Which when completed we cover in coax seal.

Cut off the S type plug from the single end of the 4-into-1 connector and strip the two wires. Terminate this cable in the junction box. Strip a section of the three-core wire that you have threaded through the cable gland in the gland plate and terminate this in the junction box. When completed we will cover with coax seal.

Connect the RED solar wire to the BROWN three-core

Connect the BLACK solar wire to the BLUE three-core

Ignore the YELLOW three-core cable.



Figure 16 Interior of a Junction Box

Step 14- Connect up the Solar Charge Controller

The controller is placed on top of the batteries in the enclosure, with the terminals at the bottom (hinge side) so that the indicators are visible through the glass panel when the door of the enclosure is closed.



FIGURE 17 SOLAR CONTROLLER

On the Solar Charge controller, there are FOUR sets of terminals – we will ignore the ones marked “remote temp sensor” (extreme left) and the one marked “remote meter connection” (extreme right). Use diagram CA1.

You will have two spare ends on both positive and negative wiring harness. We will firstly describe how the battery is wired up.

Battery connection: connect one of the positive ends of the BATTERY HARNESS CA2 to the positive on the Voltage sensor and a negative end to the negative on the same sensor.

Next, connect the second positive end off the battery harness to the positive input on the AMP sensor. Then connect a separate Positive cable to the negative input on the AMP sensor, put the other end into the positive input on the battery section on the solar controller. Put the other negative tail into the battery negative input on the solar controller.

Connect the two ends of the SOLAR Panel supply cable (positive and negative in the Solar connections on the solar controller.

For the load connect a negative cable end into load negative and connect a positive in the positive connection. The other end of the negative goes into the proteus power plug. On the positive side connect the end into the switch, with an extra piece of positive cable connect in the switch and then into the positive end of the proteus plug.

Confirmation

If the batteries have charge you should see a green led light (over a picture of a battery).

If the solar panels are connected and getting enough light, you will see another green led light (over a picture of a solar panel)

Note there is a on/off switch on the right-hand side of the controller which is "off" at this point". Pressing in the on/off button will turn on the supply to the load and a RED led will light. However, don't do this yet.

Step 15- Bolt on gland plate

At this point all cables should be wired and the boards are powered on.

You can now bolt on the gland plate to the enclosure.

Don't forget to place the foam gasket seal between the plate and the enclosure.

We have found its easier to insert the screws into the plate, then place the gasket onto the screws, then place the plate against the box and screw into place.

Step 16- Power up the boards

Press in the power button on the Solar Charge Controller

Normally the controller will beep once and the RED led will come on.

Note: If there is a short circuit anywhere, the charge controller RED led will flash and emit a continuous beeping sound. In this case, press the power button to turn off the controller and retrace and check your wiring.

You may need to turn the external power switch on depending on what position it was in when assembled.

You should see and hear the following:

1. 3 Green leds on the Proteus will light (this is the power map and if all are on shows power is good)
2. A 4th led shows I/O to the flash. It should start to flash showing the Proteus is booting
3. The Small phidget LED screen will display a Loading N4C screen..... this will indicate that the system is starting up. When its up and running it will display an screen with OVERRIDE and a measurement of voltage in the batteries, Amps going in or coming out of the batteries normally around -700 mAmps

Step 17- Screens

If you have built the Operating System and DTN applications then you can use the following steps to access the system.

1. If you have an LVDS screen, connect directly to via LVDS cable to LVDC port on card.
 2. If you don't you will have to use an LVDS to VGA convertor. (supplied from Eurotech)
 3. Plug in a Ethernet cable into the system and set the ip address on the client to 10.125.14.17 , 255.255..255.0 , this will let us ssh on to the router.
-

4. When system boots up connect to the new wireless network ESSID "n4cvillage". Once on this network, you can SSH to the Proteus board to review setup and make any local changes required. (you will need ssh keys for this)

Step 18- Connect to network

Connect to the ESSID n4cvillage on your laptop.

In your browser connect to site

`http://www.village.n4c.eu`

If successful this means you have connected to web server on the router.

If an error appears on the screen, note the error and refer to troubleshooting guide.

Ethernet adapter Wireless Network Connection:

```

Connection-specific DNS Suffix . : village.n4c.eu
IP Address. . . . . : 10.125.14.254
Subnet Mask . . . . . : 255.255.0.0
Default Gateway . . . . . : 10.125.11.20
  
```

WEB SITE

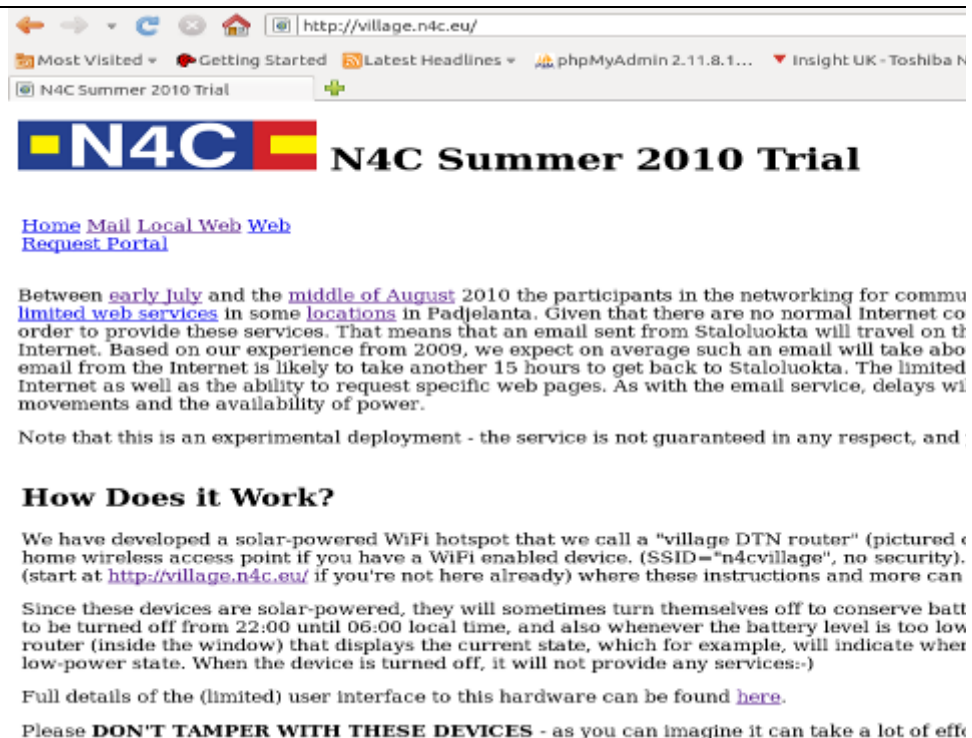

Between [early July](#) and the [middle of August](#) 2010 the participants in the networking for commu [limited web services](#) in some [locations](#) in Padjelanta. Given that there are no normal Internet co order to provide these services. That means that an email sent from Staloluokta will travel on th Internet. Based on our experience from 2009, we expect on average such an email will take abo email from the Internet is likely to take another 15 hours to get back to Staloluokta. The limited Internet as well as the ability to request specific web pages. As with the email service, delays wi movements and the availability of power.

Note that this is an experimental deployment - the service is not guaranteed in any respect, and

How Does it Work?

We have developed a solar-powered WiFi hotspot that we call a "village DTN router" (pictured c home wireless access point if you have a WiFi enabled device. (SSID="n4cvillage", no security). (start at <http://village.n4c.eu/> if you're not here already) where these instructions and more can

Since these devices are solar-powered, they will sometimes turn themselves off to conserve batt to be turned off from 22:00 until 06:00 local time, and also whenever the battery level is too low router (inside the window) that displays the current state, which for example, will indicate wher low-power state. When the device is turned off, it will not provide any services:-)

Full details of the (limited) user interface to this hardware can be found [here](#).

Please **DON'T TAMPER WITH THESE DEVICES** - as you can imagine it can take a lot of eff

FIGURE 18 INDEX PAGE OF WEB SITE VILLAGE.N4C.EU

**Step 19-
Power
up board**

**SECTION 2: OPERATING SYSTEM AND
APPLICATION BUILD**

The first step is to either buy or make a power supply for the proteus board so you can power it up and build it. You could use the 12v battery pack but it may run low on power. You will also need a USB hub, for keyboard, phidgets sensors and Ubuntu basic build.

You could use an old laptop power supply that has output of between 12v and no more than 4.5 Amps. You will need to attach the power block that comes with the board an example of the type of supply is <http://www.maplin.co.uk/multi-voltage-universal-laptop-power-supply-43515?ordercode=L23AY>

Once you have a power supply you can attach the LVDS cable to a VGA monitor and plug in USB hub and put in keyboard and USB key with build on it. Insert your SDIO 16gig card into the back of the board, the build won't complete if this is not included.

You need to have a network cable plugged into the board that has DHCP and Internet access. You also need your proxy server name and port number.

**Step 20-
BIOS
time**

To check and set bios time, turn on the system and as it boots up press F2 a number of times till you get the BIOS screen. Ensure the time is set to local time.

**Step 21-
OS build**

Down load from <http://www.ubuntu.com/server/get-ubuntu/download-the-10.04-LTS-server-build> and put it on a USB key as per instructions on web site. Once plugged in reboot the system.

If you get an image file you can dd this to a USB key

```
dd if=ubuntu-10.04-server-i386.image of =<YOUR USB DISK>
```

```
eg if=ubuntu-10.04-server-i386.image of =/dev/sdc
```

The initial build is the Ubuntu 10.04 LTS server build. This a network build so you need network cable plugged in and the Network has to be DHCP server on it to give out IP address.

During the build accept the defaults (don't worry about computer name it will be set later.

You will the name of your proxy server also, as it's requested during the build. make a note of the name and port number e.g. <http://proxy-server.xx.xx:8080>

Build with defaults except for the following options, keyboard options pick your own

It will assign a name leave default or put a name, it will get over written later.

When asked for password during the build, select one you are happy with.

At disk partition section

A single ext4 partition (no swap)

Select 'manual' – (this screen can change depending on pervious config of disk ensure it the disk ends up as described below)

Delete all partitions

Select disk

Use as: -> EXT4

Format the partition: -> Yes, format it

Mount point: -> /

Bootable flag: -> on

Finish partitioning and write changes to disk

No (no swap file)

Yes (write changes)

Next section takes about 15 mins installing base system

Do not install any applications when given the option. Select continue.

The user 'dtnuser' and password one that you are happy with

No encryption on home directory

No proxy server

Select 'no automatic updates'

Choose no s/w to install, skip to continue

- Install Grub record YES
- Remove the USB key before reboot.

Reboot

Step 22- DTN2 build

Login

Do: wget <http://134.226.36.138/code/N4Cbuild/archive/tip.tar.gz>

Or wget <http://sybil.dsg.cs.tcd.ie/code/N4Cbuild/archive/tip/tar.gz>

Download and extract N4Cbuild 'wget

Download file to local dir in seconds

Unzip the tar file , tar -xvf tip.tar.gz

Execute 'sudo ./doit.sh' in N4Cbuild directory

Need to enter proxy server and port here proxy-server.xx.xxx.ie:8080

Answer startup file.

- Type of system, router, mule, gateway
- Hardware, proteus board, ePC
- Re-configure or build

Also enter ssl password call us for that

Password for MySQL server, currently password

Email configuration -pick no configuration

Takes about 45 mins

Build complete, Reboot.

Step 23- Build

The build will commence with a number of scripts running. It stops once to ask for MySQL password, which is password. This part of the build can take about 40 mins. When it's completed the system will reboot itself.

The scripts load and build all the software you need to setup and run a village router. You need to have a network cable and access to the Internet for this to work.

Step 24- Check the build - Date and time

The DTN stack requires the date and time to be correct or else bundles will expire incorrectly.

Check the date on the Proteus is correct:

```
$ date -u
```

If not, set the date and time to the correct date and time

```
$ date mmddhhmmccyyyy
```

Step 25- Start DTN daemon for the first time

Confirm the daemon is not running

```
$ ps -ef | grep dtnd
```

And then issue the start command

```
$sudo /etc/init.d/dtn -init db
```

Or `dtnd -d -l info -0 /var/log/dtn/dtnd.log`

```
dtnuser@n4crouter-5:/var/log/dtn$ dtnd -h
usage: dtnd [opts]

opts:
  -h, --help                show usage
  -v, --version             print version information and exit
  -o, --output <output>    file name for logging output (default - indicates stdout)
  -l <level>                default log level [debug|warn|info|crit]
  -s, --seed <seed>        random number generator seed
  -d, --daemonize           run as a daemon
  -c, --conf <conf>        set the configuration file
  -t, --tidy                clear database and initialize tables on startup
  --init-db                 initialize database on startup
  --console-addr <addr>    set the console listening addr (default off)
  --console-port <port>    set the console listening port (default off)
  -i <id>                   set the test id
dtnuser@n4crouter-5:/var/log/dtn$
```

FIGURE 19 HELP OPTION FOR DTND

This command initialises the database and starts the daemon.

This command can be run at any time BUT IT WIPES THE EXISTING DATABASE IF IT EXISTS AND ANY BUNDLES IN TRANSIT ON THIS MACHINE WILL BE LOST. IT CHANGES THE OWNERSHIP OF THE FILES AND PAYLOAD DIRECTORY.

The ownership of `/var/log/dtnd.log` should be `dtnuser:dtmuser`

The ownership of `/data/dtn/payload` should be `dtmuser:dtmuser`

To query the DTN daemon a new set of commands were put in place (`dtnd-control`)

```

dtntuser@n4crouter-5:/var/log/dtn$ dtnd-control
unknown operation
dtnd-control [-port port] stop|check|logrotate|bundle_stats|daemon_stats
|reset_stats|route_dump|link_dump|bundle_list|registration_list|gettimeofday
|[-id id] bundle_info
|[-id id] bundle_del
|[-id id] bundle_dump
|[-id id] bundle_expire
dtntuser@n4crouter-5:/var/log/dtn$

```

FIGURE 20 HELP OPTION ON DTND-CONTROL

Dtnd-control with options to check the daemon on a port, to stop, check, logrotate, bundle stats, daemon stats, reset stats, route dump, link dump, bundle list, registration list, and get time of day

Step 26- Apps Install

Running applications - Apache2, Dovecot, Postfix, MySQL, DTND, PBMD

Monitoring –Monit was installed to monitor, cpu, disk space, power management , wifi access (hostapd), dhcp, dovecot, postfix, mysql. We also check the security on the file system using monit.

We checked the dtn registrations were running

Registrations running should be , dtn, ping, addmailaccount, mailsync and mailack

Step 27- URL fetching

Using a combination of MySQL ,N4Cmiddleware and squid a user can make a request for a web site that they know already. They can make a private or public request. The request needs to be tagged as either public or private at the time.

The requested is then tracked in the database and if it's a private request only the requestor will see this request otherwise all public requests are also displayed as either available or pending. Pending means the request is gone and we are awaiting result

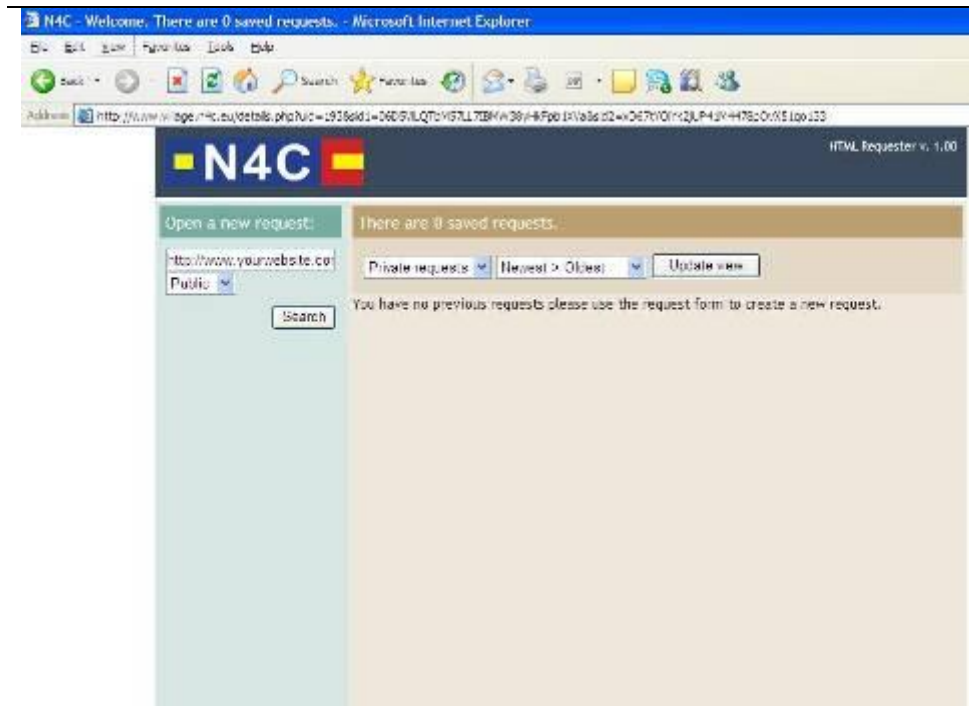

FIGURE 21 INDEX PAGE OF WEB REQUEST APPLICATION

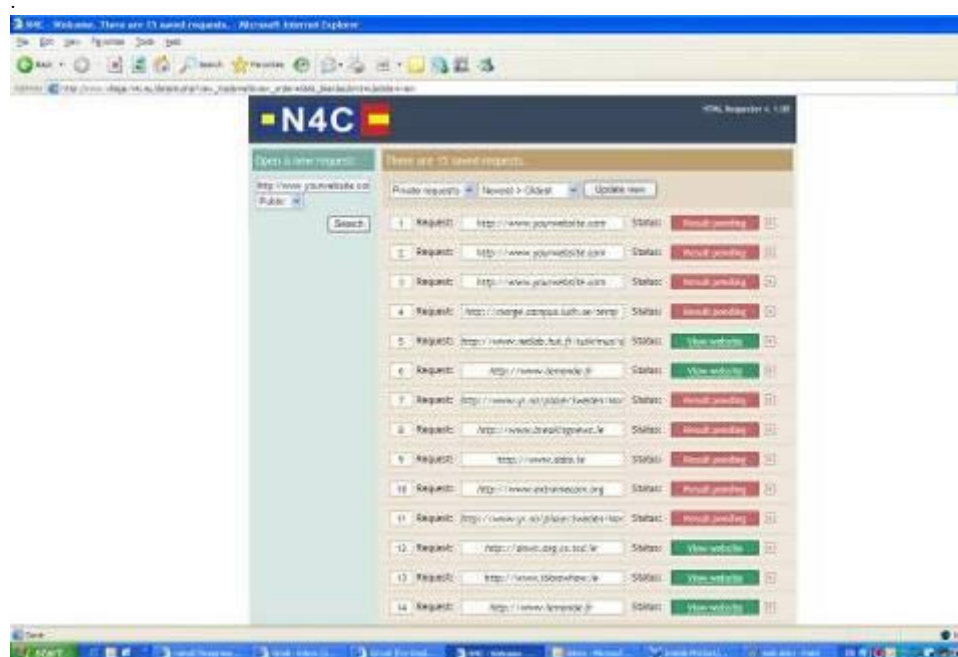

FIGURE 22 WEB REQUEST APPLICATION WITH SOME REQUESTED SENT AND RECEIVED

Step 28- HTTP pushed content

There is some generate static WEB content on the Web server, this related mostly to N4C sites. There is also pushed web content on the router.

Some sites which such as Norwegian weather sites and local news where we retrieved updates off their websites daily and updated the village routers and gateways with. These sites can be accessed of the home page.

**Step 29-
MAIL**

We presented a mail system for users. They would firstly need to create a mail account of the www.village.n4c.eu . When creating the user we appended and router name on to the end, e.g fred became fred-r1@village.n4c.eu . This was to stop duplication. You could also have your external email address added, we would send this account an email to say account created.

If the user had no email client on their own system (laptop, notebook or smartphone), they could access email via Squirrel Mail on the router.

The design is using, DOVCOT an open source email server (store), we set it up as an IMAP email server and POSTFIX as the Mail transfer Agent(MTA)

The system should not be ready to test. Connect to the SSID of “n4cvillage” and review the website and follow the instructions on setting up email, making a web request or looking at pushed web content.

Part 3 STAND ASSEMBLY**Step 30-
Solar
stand**

The solar stand comes in a foldable form. Once opened out take out the 2 poles and fold the base out. The pole with the extended arms goes in first and 2 of the legs screw into either side of the base and the other 2 are attached by the clips provided, so you get a solid cross shaped base.



FIGURE 23 SOLAR STAND UNFOLDED



FIGURE 24 STAND



FIGURE 25 CLOSE UP OF LEG WITH CLIP



FIGURE 26 CLOSE UP OF LEG WITH SCREW



FIGURE 27 CLOSE UP OF CENTRE POLE

Step 31- Solar Panel mounting

We used existing holes on the solar panel to mount brackets which we then mounted on to metal struts about 115cm long. These mounting brackets are ordered with the solar panels

These struts were held on to the solar stand by U bolts. The struts are on the BOM as are the U bolts.

It is best to mount the panels onto the struts when the struts are attached to the stand. Leave all nuts loose till all panels are on then tighten up the nuts and bolts.



FIGURE 5 SOLAR PANEL MOUNTING HOLES AND U-BOLTS



FIGURE 28 SOLAR PANEL MOUNTING HOLES BRACKETS

Step 32- Main antenna attached

Attach the main antenna to the top of pole and attach cable item 8 to the end screw tight. The other end attaches to the exposed antenna connection on the router box.



FIGURE 29 COAX SEAL CONNECTIONS

**Step 33-
Water
proof**

Use coax seal tape to wrap around exposed connections

Antenna to cable, both ends.

Once the plate is attached the seal around the edges of the plate.



FIGURE 30 SOLAR PANEL AND STAND WITH ROUTER

4. BUILD REFERENCE DOCUMENTS

CA1 - MAIN POWER HARNESS

CA2 - BATTERY HARNESS

CA3 - SERIAL CABLE

PL1 - VILLAGE ROUTER DIAGRAM

PL2 - SUPPORT BOARD LAYOUT

BLANK

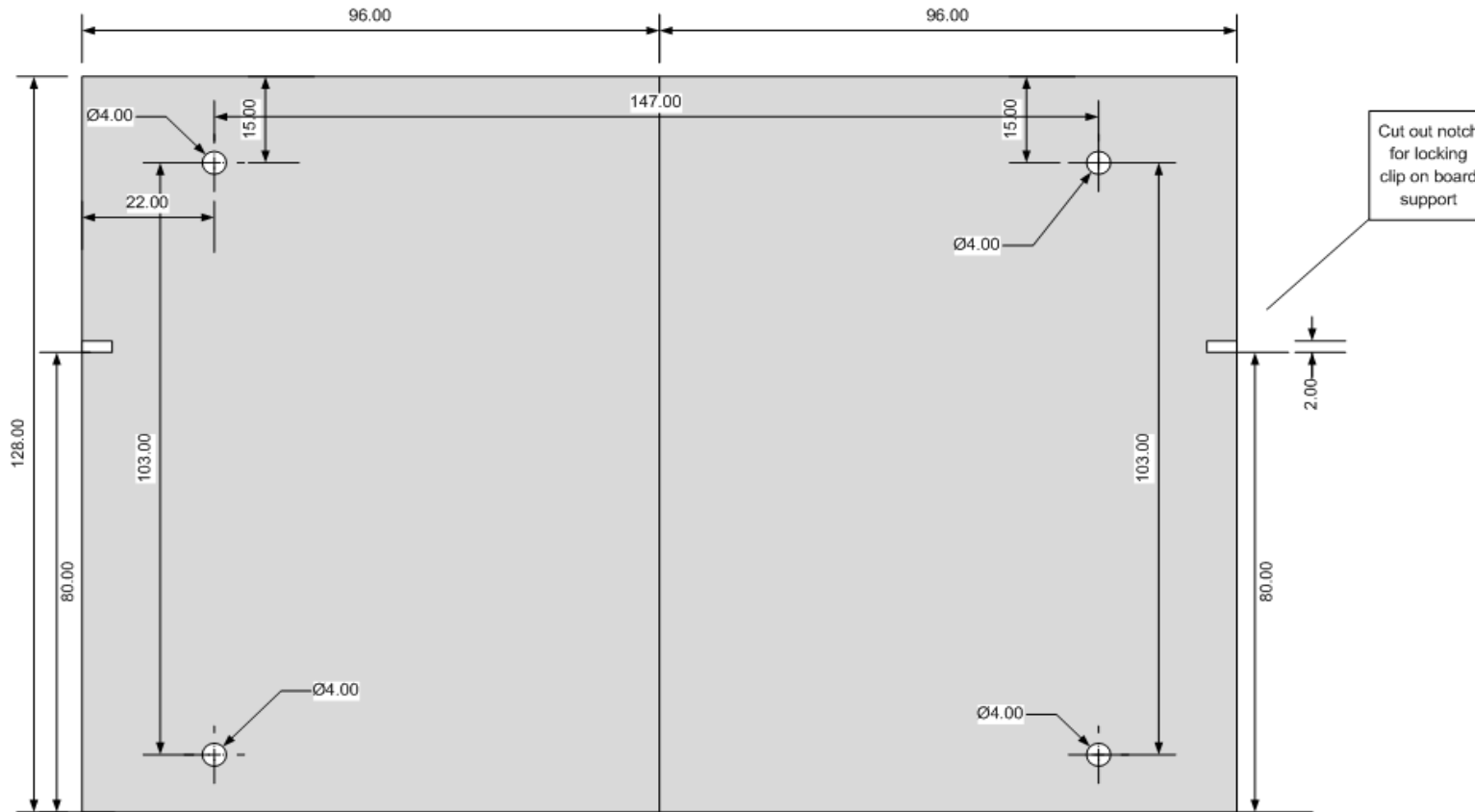



Note: All holes 4mm diameter
 Support board is two pieces of matrix board
 96mm x 128mm (3.75 in x 5.00 in)

	Physical Layout 2			
	Support Board			
N4C Village Router	SIZE	FSCM NO	DWG NO	REV
PL2	SCALE	1:1	PL2	PL2
			SHEET	1 OF 1

(Cable Length: 20 cm)

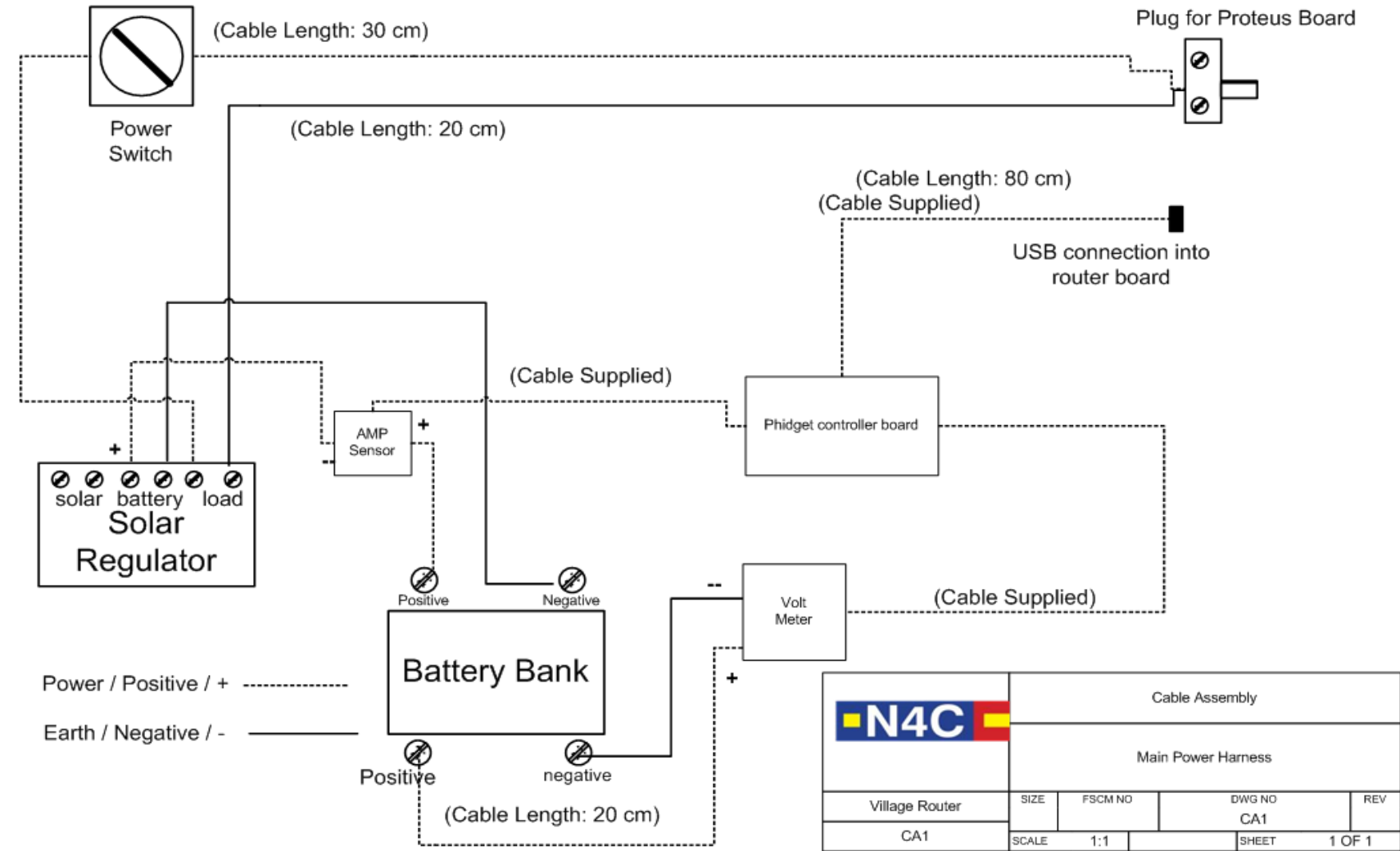
(Cable Length: 30 cm)



	Cable Assembly			
	Main Power Harness			
Village Router	SIZE	FSCM NO	DWG NO	REV
CA1	SCALE	1:1	SHEET	1 OF 1

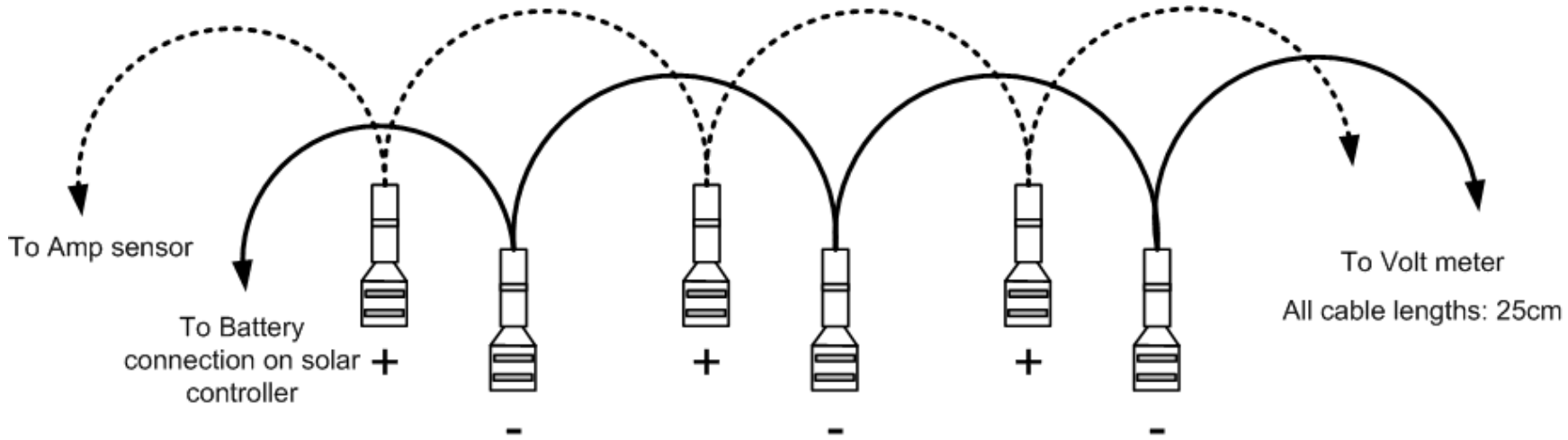

Power / Positive / + - - - - -

Earth / Negative / - ———

	Cable Assembly			
	Battery Harness			
Village Router	SIZE	FSCM NO	DWG NO	REV
CA2	SCALE	1:1	SHEET	1 OF 1

J8 Pinouts

1 DCD	2 DSR
3 RXD	4 RTS
5 TXD	6 CTS
7 DTR	8 RI
9 GND	10 GND

DB9 Pinouts

6 DSR	1 DCD
7 RTS	2 RXD
8 CTS	3 TXD
9 RI	4 DTR
	5 GND

**J8 Hirose
10-way plug**
DF11-10DS-2C

**DB9
Male Plug**

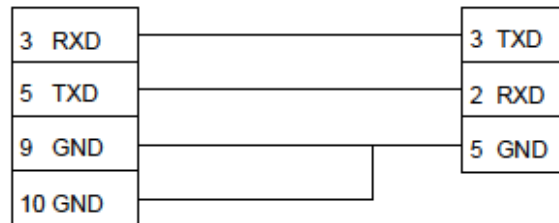

**Cable header on
Proteus Board**



	Cable Assembly 3			
	Serial Port Cable			
Village Router	SIZE	FSCM NO	DWG NO	REV
CA3	SCALE	1:1	CA3	1 OF 1

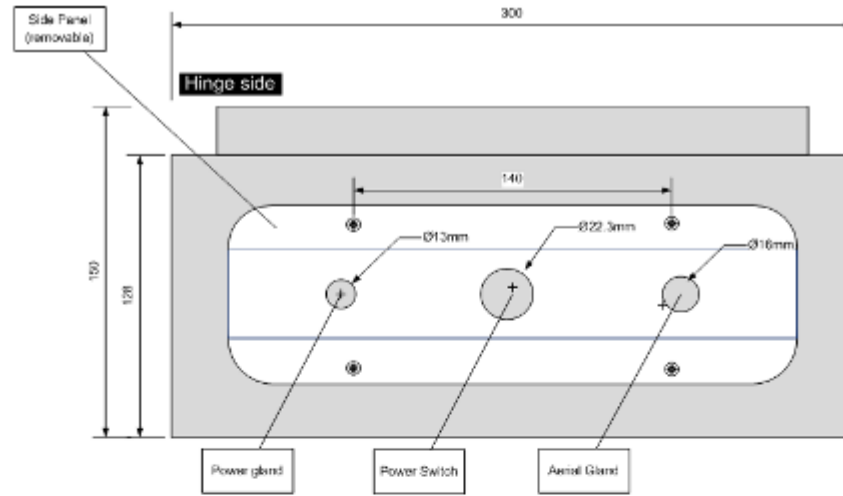
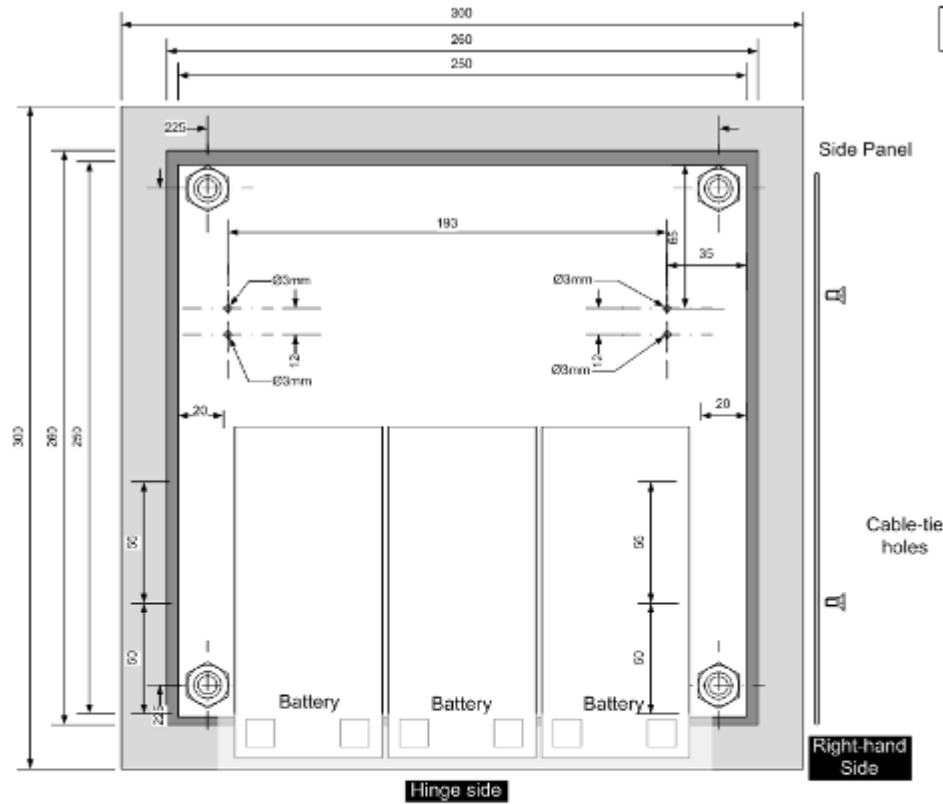

	Physical Layout			
	Physical details of the village router and layout of the various components Drawings not to scale			
Village Router	SIZE	FSCH/ND	DWG/ND	REV
PL1	SCALE/NA		PL1	1.0
			SHEET	1 OF 1

Checklist for Village router Build:

Fill this checklist when your work is done

<input type="checkbox"/>	Apply sticker on the box with the router name and contact details.
<input type="checkbox"/>	Apply waterproofing to gland plate
<input type="checkbox"/>	Apply waterproofing to antenna, power and on-off switch
<input type="checkbox"/>	Apply waterproofing to solar panel 4-way connection
<input type="checkbox"/>	Ensure door is locked and key removed
<input type="checkbox"/>	Ensure enclosure is mounted correctly and all cables are looped to prevent water ingress